

INSTRUCTIONS FOR USE

MOUNTING KIT



moonboon
designed for better sleep

IMPORTANT! READ CAREFULLY AND KEEP FOR FUTURE REFERENCE

WARNINGS

- Do not use this product without reading the instructions first.
- Stop using the product as soon as the child can sit or kneel or pull itself up.

IMPORTANT INFORMATION

- Install this mounting kit only in solid wooden beams or stable wooden ceilings with a minimum thickness of 12 mm.
- Your baby can fall out if the product is not installed correctly.
- The Mounting Kit is approved to use with Moonboon's baby hammock, cradle and twin baby hammock.
- We recommend having a professional craftsman install the product if you are unsure about the correct installation or your ceiling material. Ensure they read this user manual before installation.
- Only install the ceiling hook vertically, e.g. into a ceiling. The ceiling hook is not developed or tested towards horizontal installation, neither in beams nor walls, nor is it suitable for installation in sloped walls or sloped ceilings.
- Before each use, perform a "wiggle and pull test" of the installed mounting kit, giving the strap a small wiggle or tug to ensure that the Mounting Kit is firmly secured and won't shift, loosen, or detach under pressure. While performing this test, absolutely no movements of the hook are allowed.
- Before each use, check that the mounting strap is securely attached to the ceiling hook.

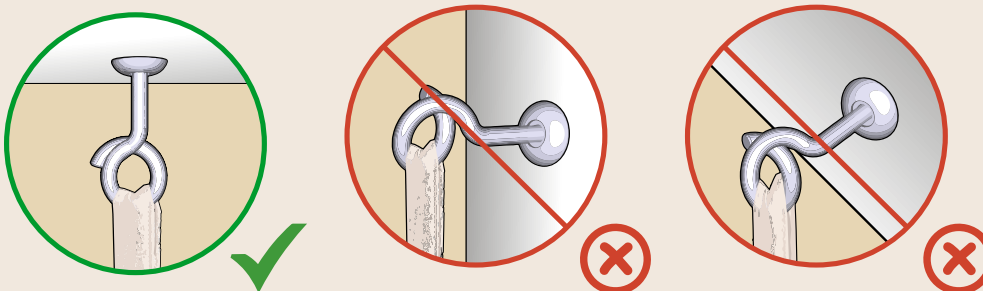

WHAT'S INCLUDED

- 1x Mounting strap (50 cm long / 1.6 feet long)
- 1x Stainless steel ceiling hook

INSTALLATION

Follow the following instructions carefully to ensure correct installation and mounting.

1 Use a \varnothing 4 mm wooden drill bit to make a hole of minimum 52 mm in depth.

2 Screw in the ceiling hook until the rosette washer (the white ring) closes tightly against the ceiling.

The rosette washer secures a nice smooth finish between the hook and the ceiling.

3 The mounting strap is now ready to be attached. First choose how long you want the strap to be: There are 6 options, one for each loop on the strap.

Securely attach the mounting strap to the hook, then connect your chosen Moonboon product to the bottom loop.

4 Before putting your child in the baby hammock or cradle, test the installation with 20 kg (44 lbs) load. While performing this test, absolutely no movements of the hook are allowed.

The mounting kit is now ready for use. Before you put your baby in the baby hammock or cradle for the first time, read the **WARNINGS** and **IMPORTANT INFORMATION**.

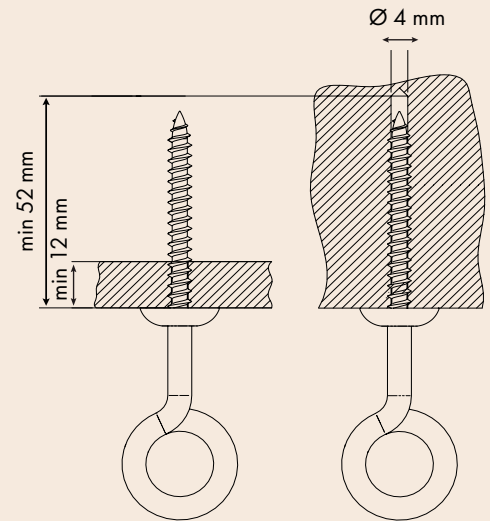

Please note

When using a Moonboon cradle bouncer, be sure to connect it to the strap with the included carabiner, and check that the carabiner is securely locked after installation.

Please note

You need a minimum of 2 meter / 6.5 feet from floor to ceiling in order to use the mounting kit with both a Moonboon Motor and a cradle or baby hammock mounted in it.

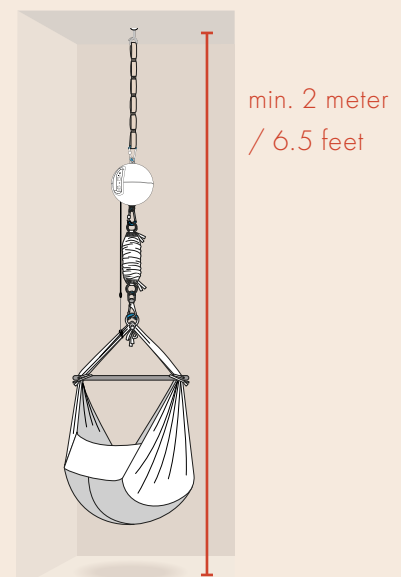

ADJUSTING THE LENGTH OF THE MOUNTING STRAP

The mounting strap can be adjusted in length using 6 loops to shorten or lengthen the mounting strap to fit your needs and height of ceiling.

To adjust the mounting strap, find the strap loop that fits the wanted length and mount the chosen loop on the ceiling hook.

If you want to change the length of the mounting strap, detach the mounting strap from the ceiling hook, and adjust it.

Please note

You baby must under no circumstances be placed in the baby hammock or cradle during length adjustments.

If using a cradle bouncer, it must be turned off during any adjustments.

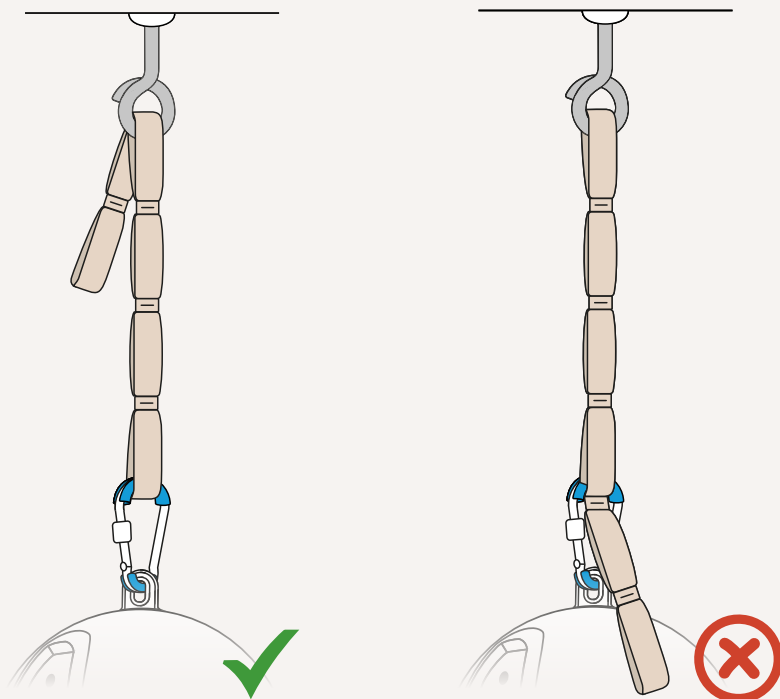





Updated 02.2025

Produced by Moonboon International ApS
Lindgreens Allé 9, 1 tv, 2300 Copenhagen Denmark

hello@moonboon.com
www.moonboon.com
+45 89877575

UK: Unit 142091, PO Box 7169
Poole, BH15 9EL, United Kingdom

 moonboon_official  moonboon_official  moonboon.com